

ផាប់ ប៉ាវ៉ាម

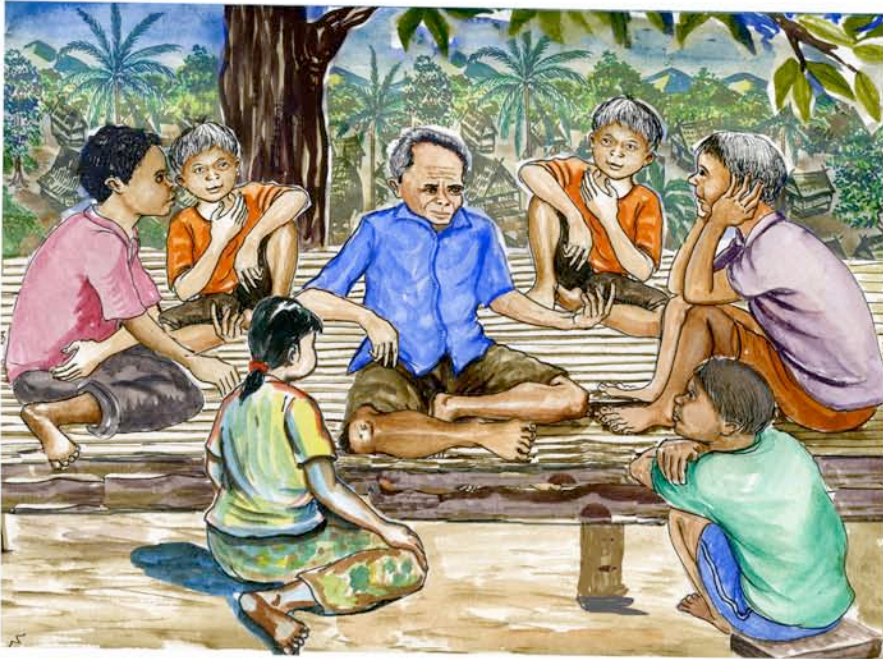

សុនសាត តំពូន



សៀវភៅ

ពាក្យបណ្តៅជនជាតិទំពួនភាគ៣

**សមាសភាពក្រុមការងារ**

**អ្នកស្រាវជ្រាវ**

លោក ធៀង សារឿន

លោក ឃិន ឃើន

**អ្នករៀបរៀង**

កញ្ញា ផង ឌឹម

លោក ធៀង សារឿន

**គូរ និងរចនារូបភាព**

លោក ពុន ទូញ

**គណៈកម្មការត្រួតពិនិត្យ និងកែសម្រួលភាសាខ្មែរ**

លោក វ៉ាង វីញ

លោក ស្រែន ក្វាវ

លោក ឡាន ទិត

លោក ក្វាស ទិវ

លោក ដេង សុង

លោក ឃិនសុខសំអឿន

លោក ធៀង សារឿន

លោក បេច យេក

**ទីប្រឹក្សាខ្មែរ**

លោក អេនឌ្រូ ខាសិន

កាលាត៍ ញ៉ា អ៊ិយ៍ អន់តើប  
ទយ កីង ?

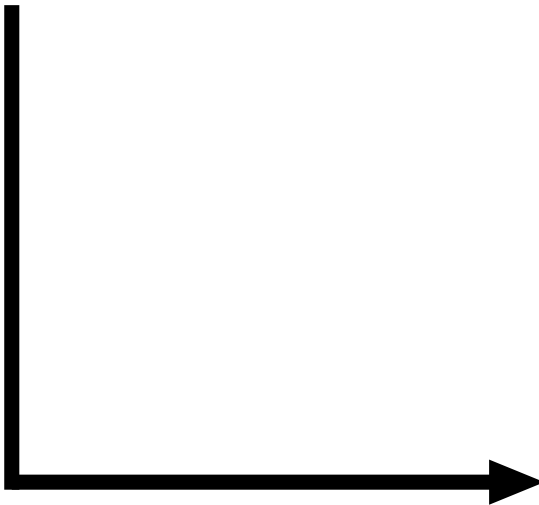

# អន់ទ្រប់

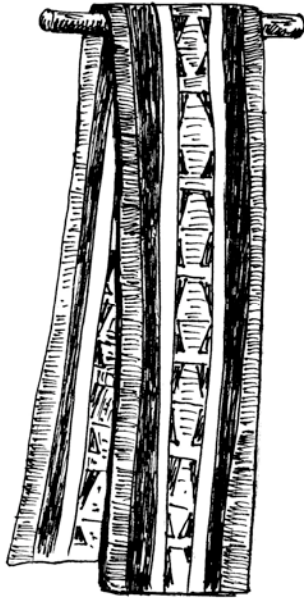

កាណាត៍ ញ៉ា ចារ៉ឺប ចារ៉ឺប

ការអប់ ម៉ាស ?

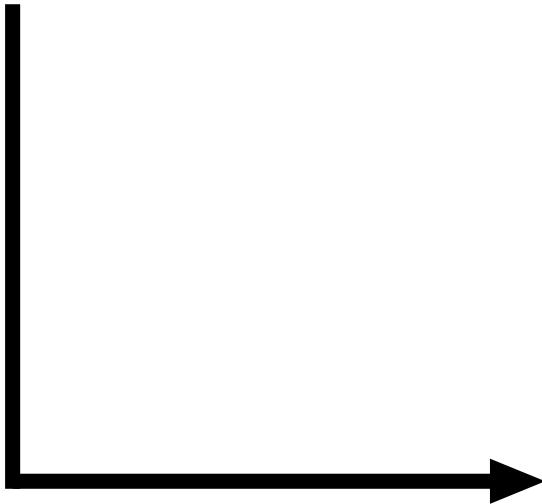

# ស្លែ ពោស

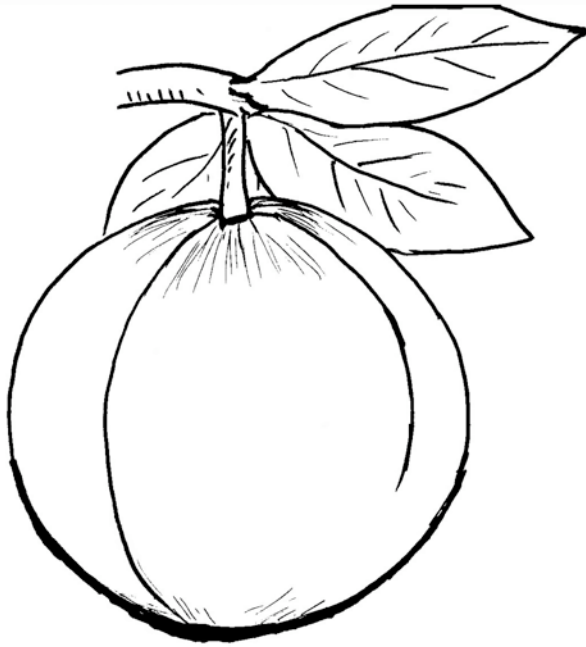

# កាលោតិ ញ៉ា

អ្វី ចិ អន់តុក អញ្ចុជុត ដាត់ៗ

ប៉ាត់ ក្រាត់ អ្វី សាឡុន ?

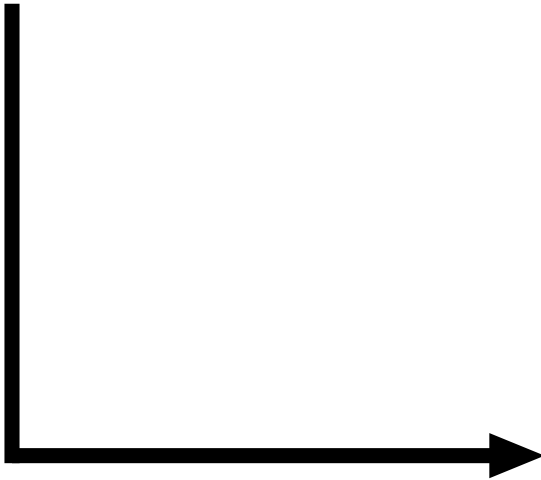

# តារ៉ាង

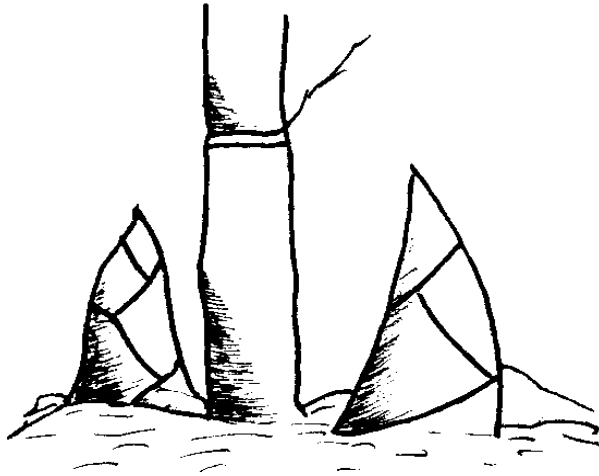



កាណាត៍ ញ៉ា ឡឹង ចិ ទីល ក្រាត់  
តែប ពឹង មុង លើយ ?



# ប្លែង អំប៊ុត លូ ប្លែង ម៉ាឡូ



កាណាត៍ ញ៉ា ត្រង់ អូ អូ ហ្សា  
ឡាកោ កាង ប៉ាន់តឹង អំបារ ហិ ?

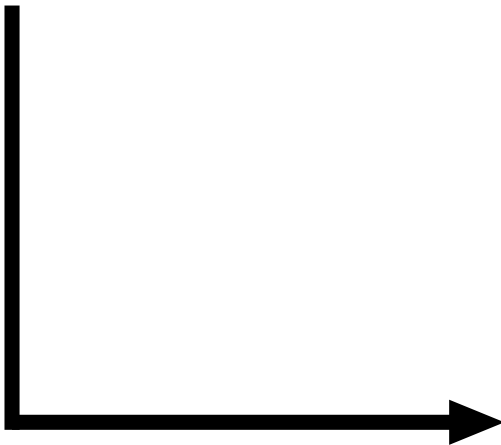

# កាតែ ហ៊ី

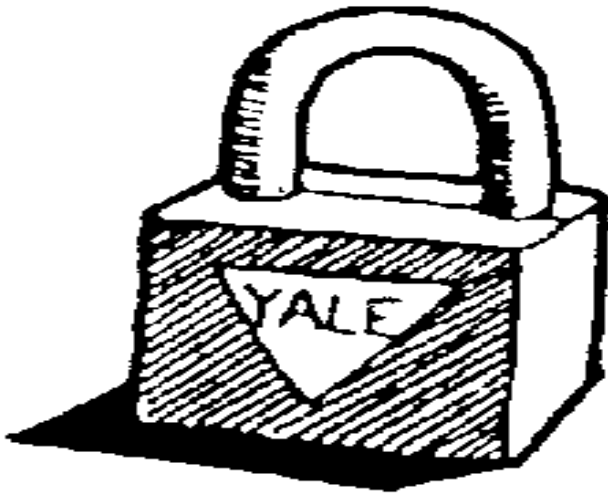

កាណាត៍ ញ៉ា កាដាវ៉េ រាហ្សាំង

កាមុំង រាសាយ្យ ?

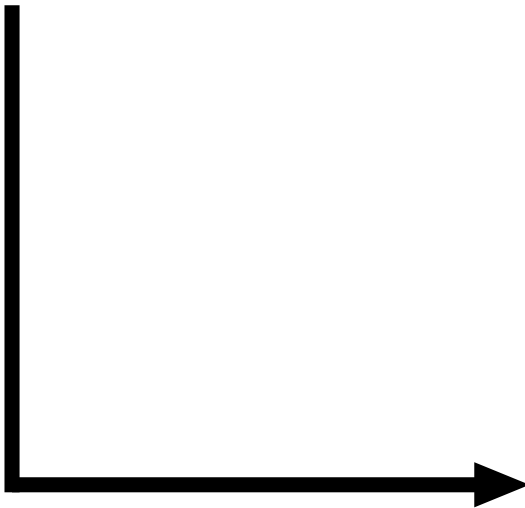

# ពោល លូ អង្គឃ្នាត

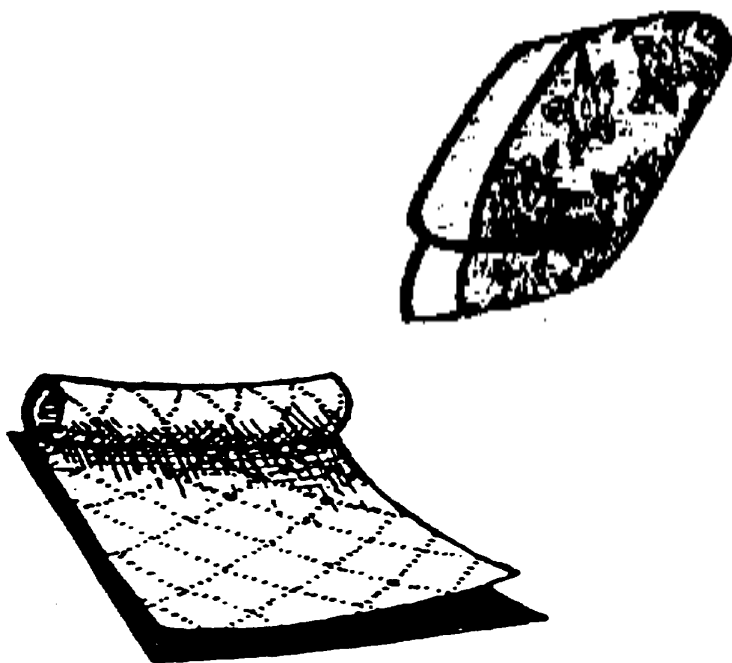

កាណាត៍ ញ៉ា ជុង រ៉ុ តិ កាតាប័ ?



# ពូ កាច់





កាណាតី ញ៉ា ប៉ាការី ម៉ោញ ខែ  
ប្លែ ម៉ោញ សាណាំ ?



# កានៃត ខោស



កាលណា ញ៉ា គ្រុក អង់គ្រុក  
សាន់តុក កល់ ម៉ែន ?



# ប៉ោក ប៉ាសីង ទៀក



កាណាត៍ ញ៉ា ម៉ែត អង់ហ្សាំង

គន សាតាក់ ឡាច ?



# កាំស្រក

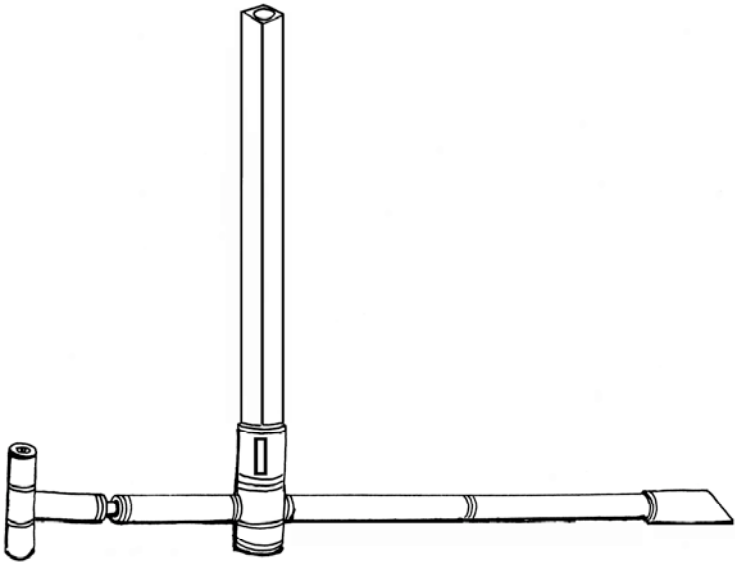

កាលណា ញ៉ា អ្នក ថ្ងៃ ថ្ងៃ អន់តុក  
អញ្ជូន ដាច់ៗ ប៉ាត់ ក្រាត់  
អ្វីក៏ អញ្ជូន ប្រើ ម្នាក់ ?



ជ្រូង

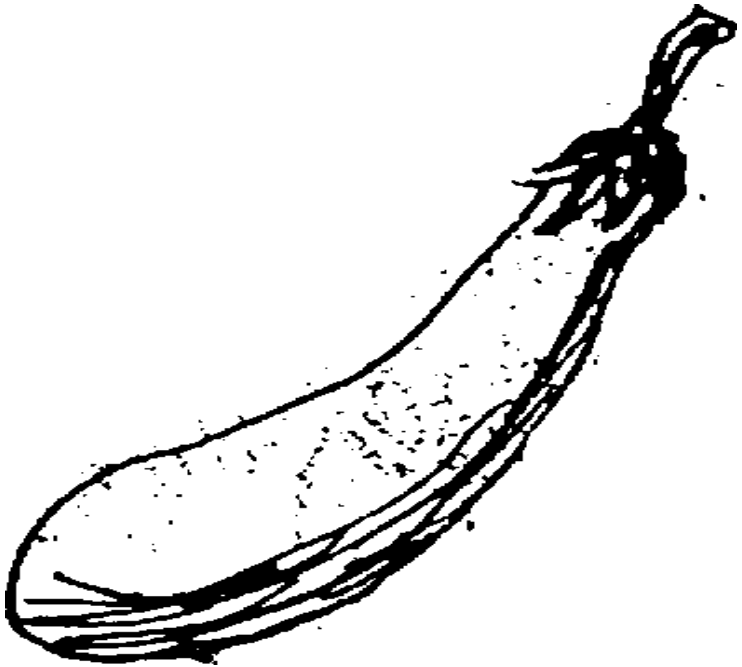



កាលណា ភ្នំ ជុំ ត្រៃ  
ឡាកោ ភ្នំ ម្នាក់ ខុន ?

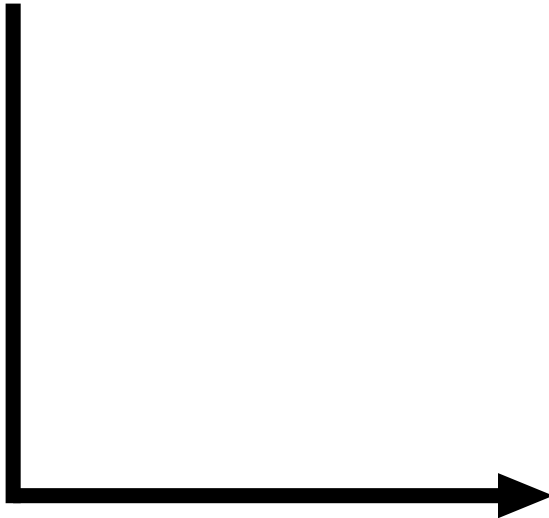

ဗျံ

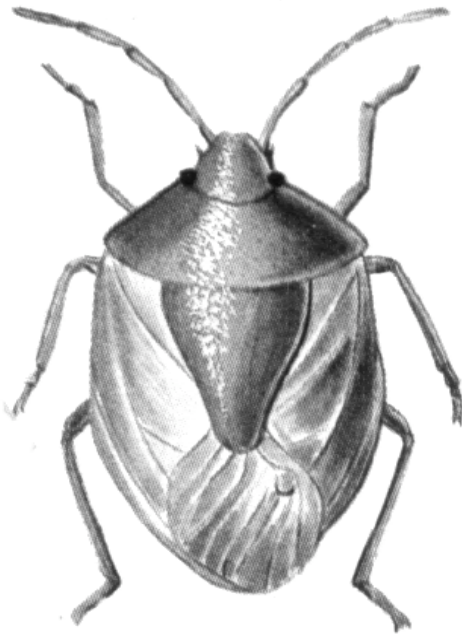

၂၆

កាលណា គឺ ញ៉ា ឡូច រាំងហារ  
អូ ទី ប៉ាការ ប្លែ ?



# ស្រូវ

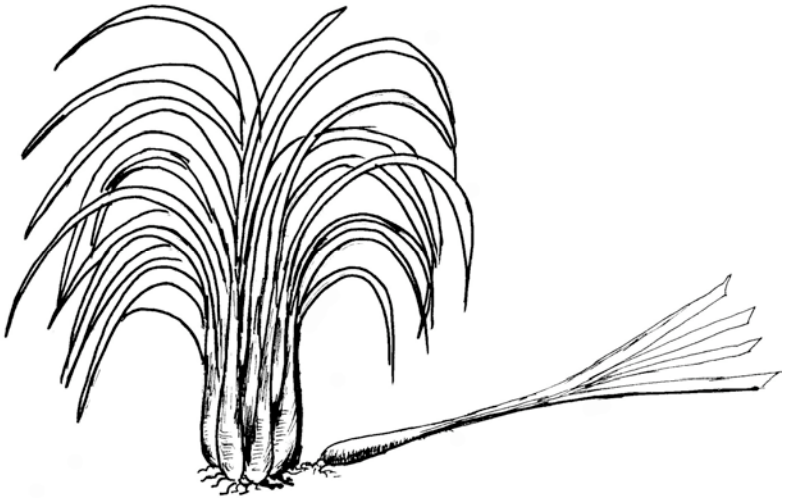

កាណាត៍ ញ៉ា ចាក ជុង អញ្ចុជិត

រ៉ាឡូរី ជុង ប៉ែង ?

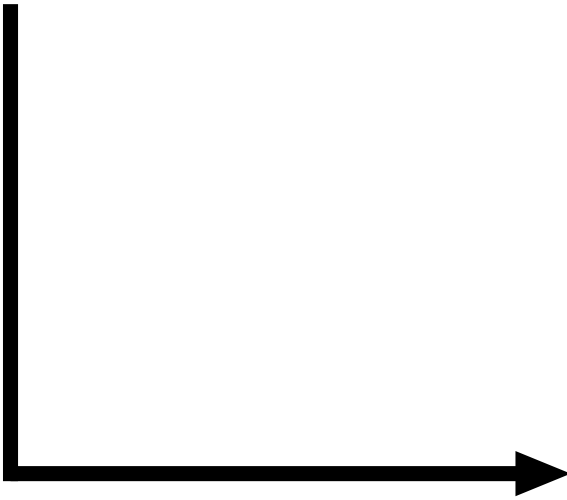

# ” ภาเถះ ”

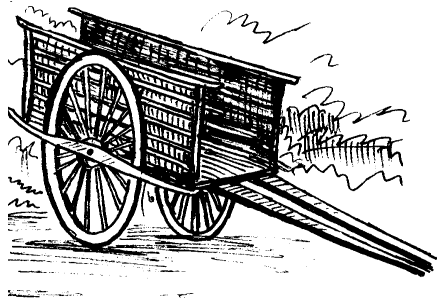

កាលណាគឺ ញ៉ា សាគក សាតែក

បើក កានៀង អន់តិគី ព្រី ?

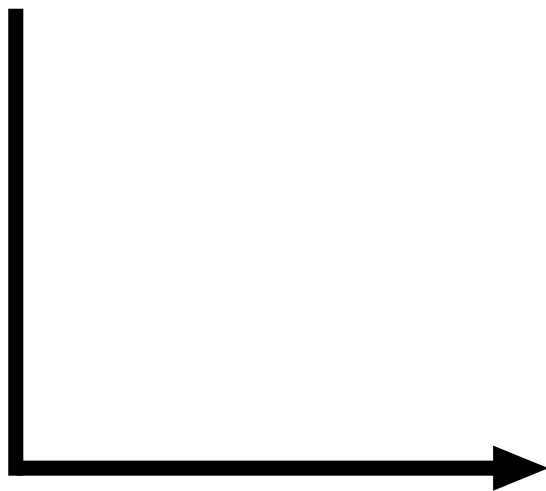

# កាណប់





កាណាត៍ ញ៉ា កើយ ប៉ាអង់ ហារវ  
តាំងហារវ តាឡេ្យះ អញ្ចុជុ អារវ អ្នាត  
ពីង តេះ ?



# សារលោក

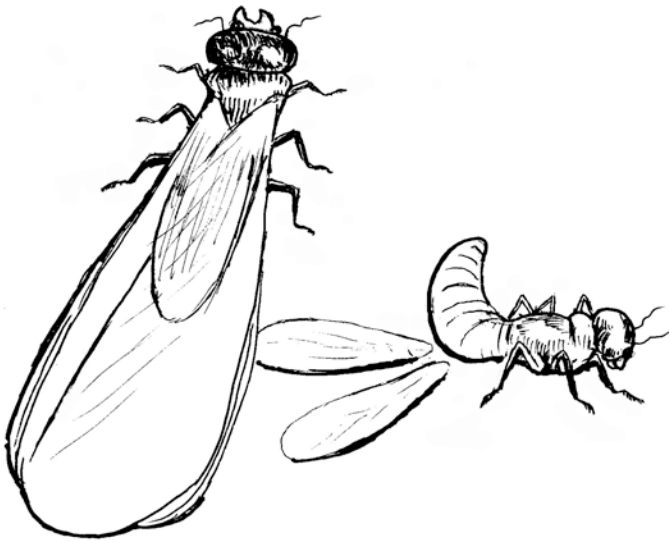

កាលណា គឺ ញ៉ា ទី ជុំង អូ អូ រំលំ  
ទី ដឹង កលំ អូ ទី ម៉ាត់ ?

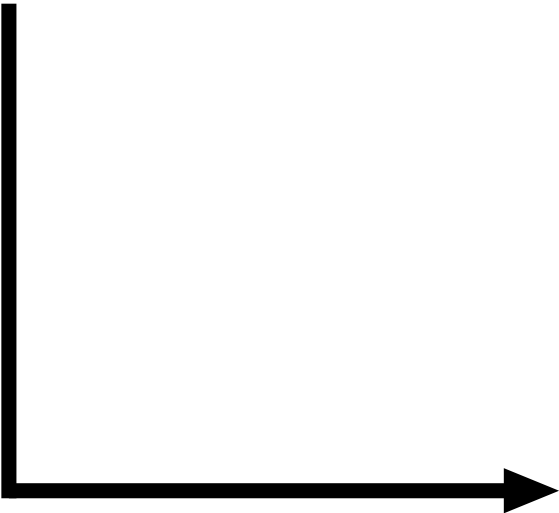

# ប៉ានីម



កាលាគី ញ៉ា គន ញ៉ាំ ម៉ៃត  
ប៉ាណាំ ហារវ ?

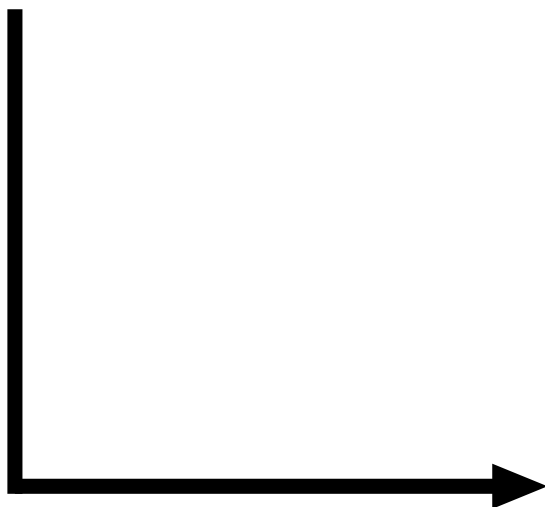

# ឃ្លៀង អ៊ែក

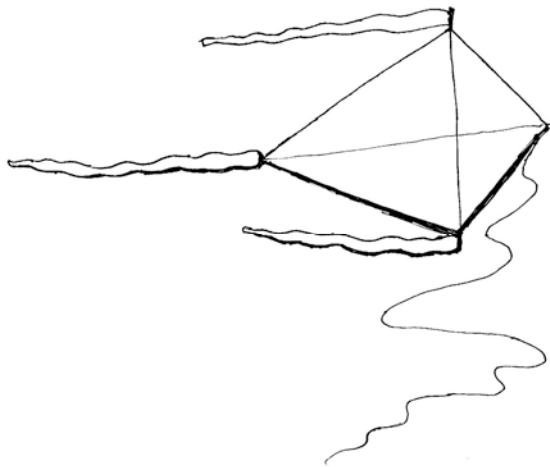

កាលាតី ញ៉ា "វាត្តិង" វាត្តង ព្រយ

ជុង កាប្លូរី វក់ ?

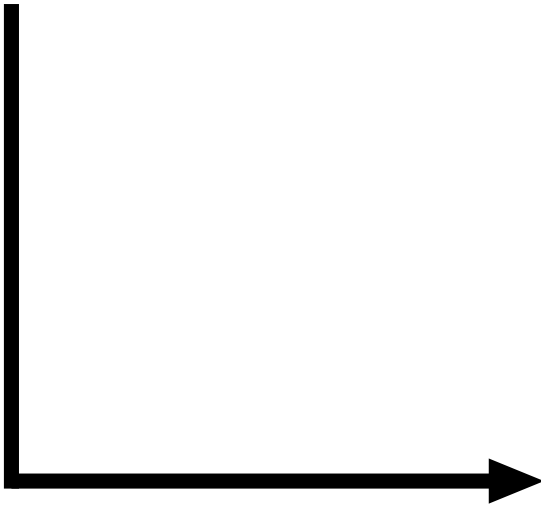

# “រាយ៉ាង ប៉ាអូ”

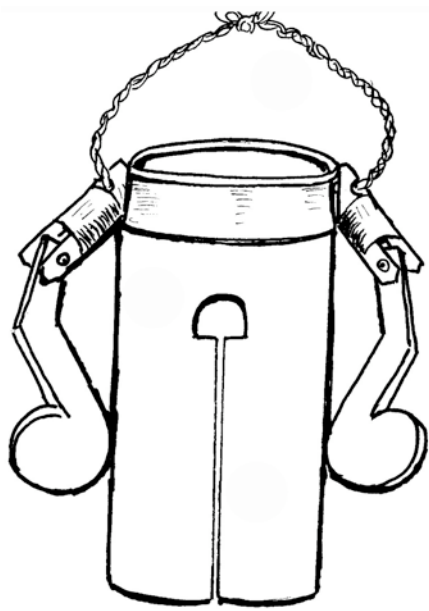



កាលណា ឆ្នាំ ជុំ ត្រូវ អង្គកូ

រាំងតែត ?

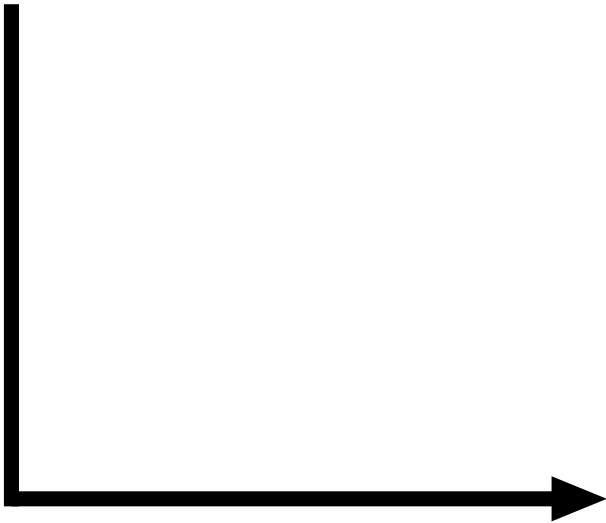

៣៩

# តែត អង្គតែត

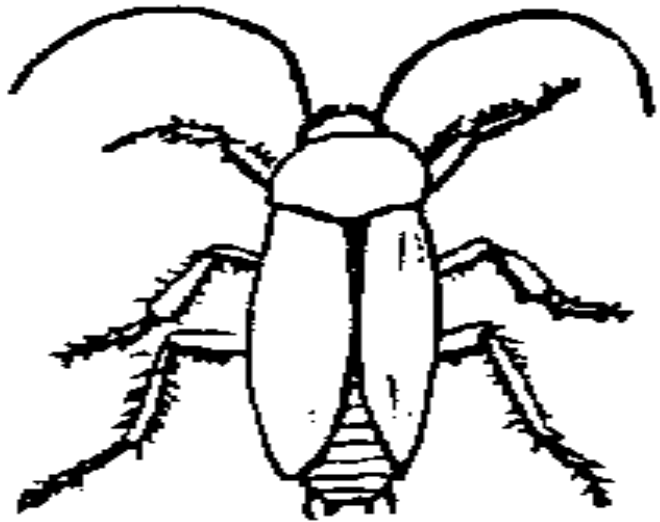

កាលណា ញ៉ា ថី សាំងក្រោស  
ជា ពិន កាន់តើស អើ ក្រិញ ជុង  
តី ?

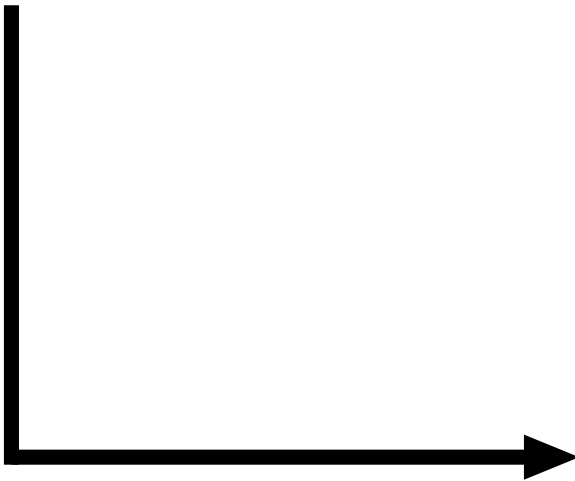

”  
ម៉ា

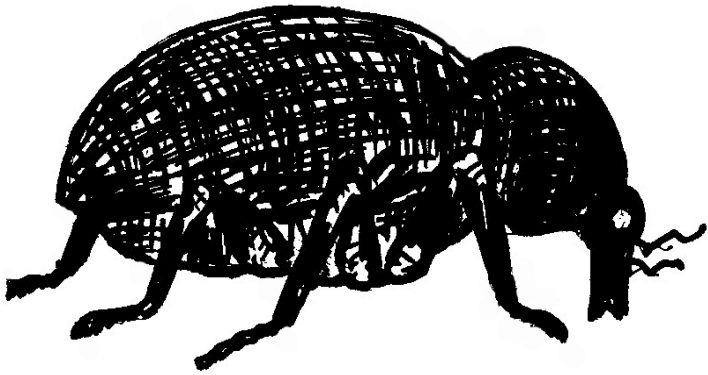

កាលណាគឺ ញ៉ា ប៉ុងឡែ ប៉ាញ៉ូ  
ដឹង ស្រេច ឡាតោ កាង ប៉ាប់  
រ៉ែ៖ ១ ?

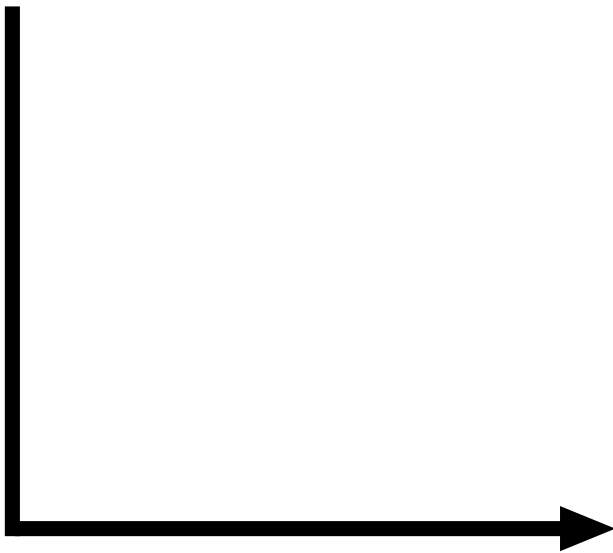

# កាថា ប៉ៃ ប៊ូត

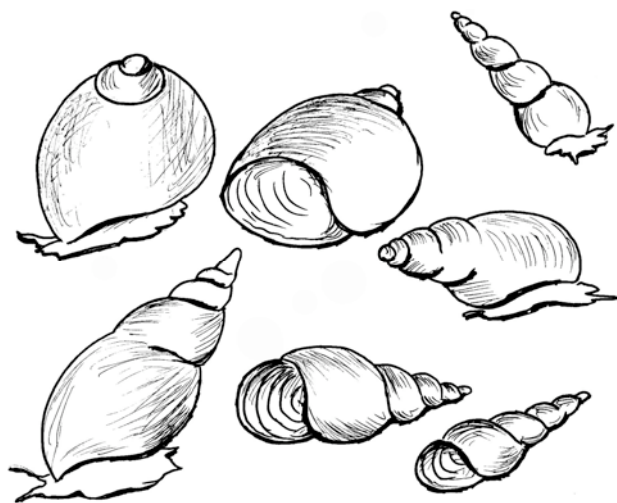

កាលណាគឺ ញ៉ា កាដាវ៉ា "វាប្លែង

កាម៉ាំង "វាញេង ?

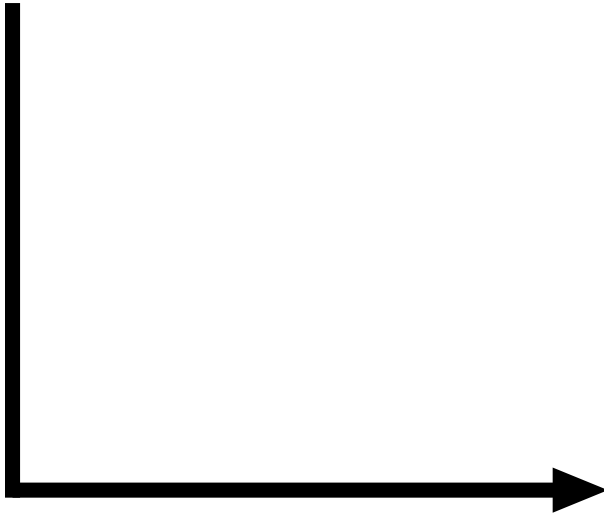

# ម៉ៅ ក្លាត់

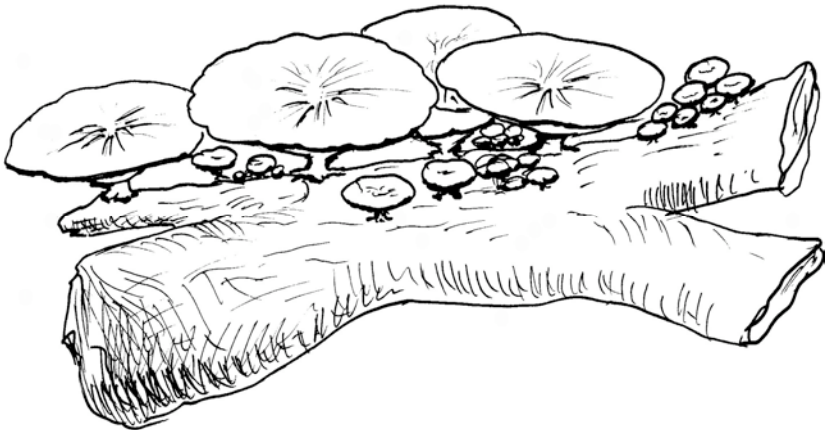



កាលណា ញ៉ា ត្វាល់ ម្នាក់ ខុន

ហ៊ិន អំពិច ព្រី ?



# ម៉ៅ ប្តូ



កាលណាគឺ ញ៉ា ប្លឹមៗ ប៉ាម

អុញ កិត ?

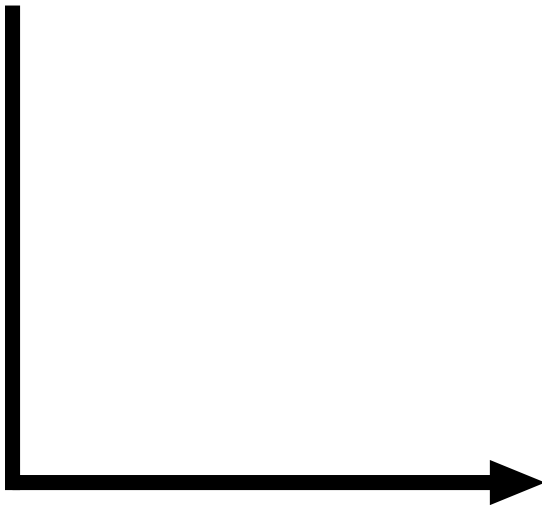

# អុញ កាបង .តាគៀង. ជ្រុង

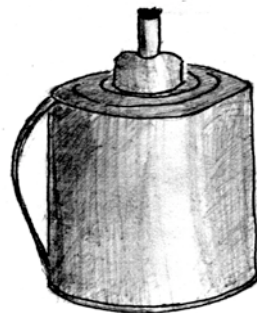
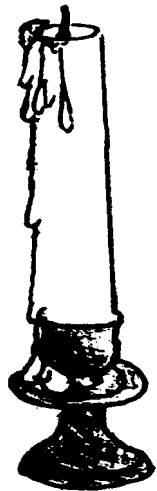

កាណាត៍ ញ៉ា ត្រុកៗ ប៉ាម៍ ហត់

សាណុក ពឹង ពិរ ?

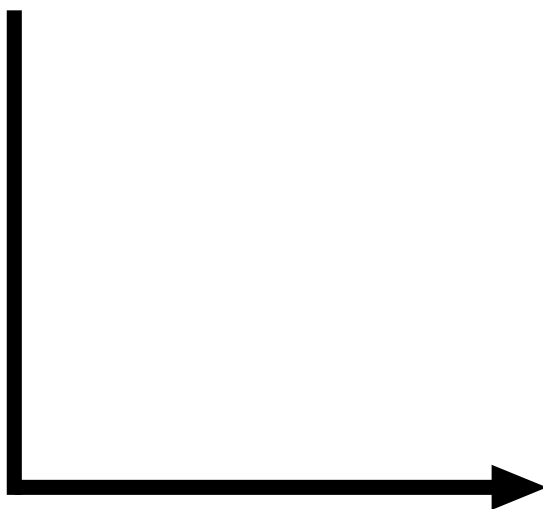

# ក្តី សាំងហ៊ី ពរ

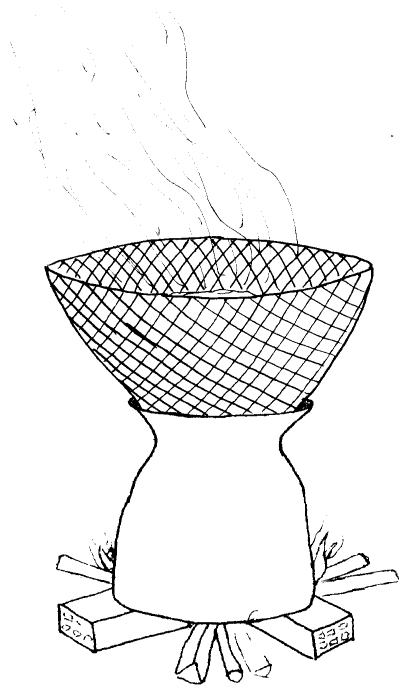

កាណាត៍ ញ៉ា ញ៉ាក់ ក្យាំង រ៉ែអ៊ី  
ឡាំងហ្សាំង រឿក ?

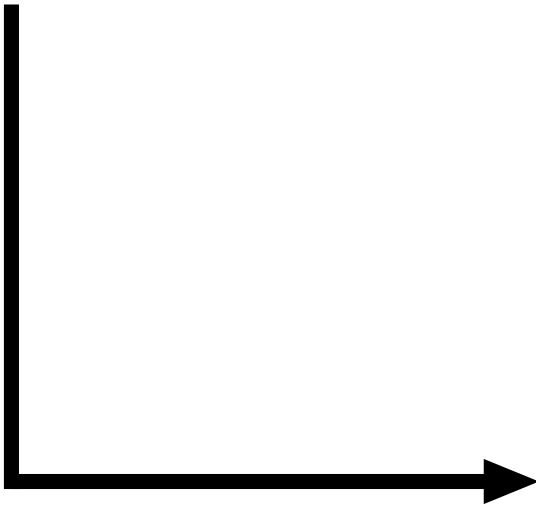

# ប៊ែប

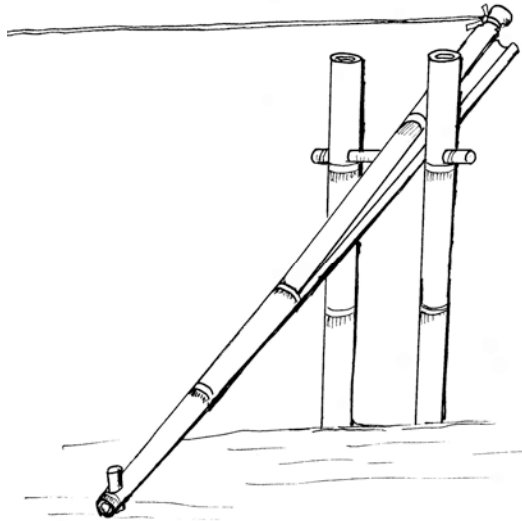



កាណាត៍ ញ៉ា តេះ អូ ទីល

ហាត់តា តប់ ញ៉ា កា អូ កើត ?

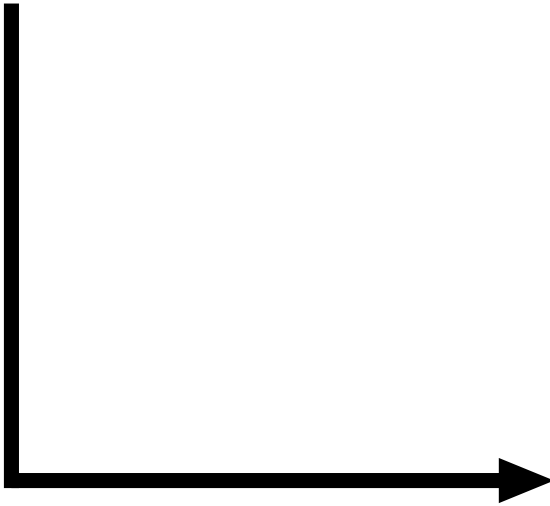

# អំប៊ូរ អុញ



កាលោគី ញ៉ា ប៉ុងៗ ចាបុង  
ទៀក តាំងលើ ?



ព្រះ ម្ចី



កាលាត៍ គឺ ច្រា ប៉ាញ៉ូ ឡាភោ ថាត់  
ប្លោ តាំប្រ័ត៍ តោ អន់តាន៍ ជុង ?

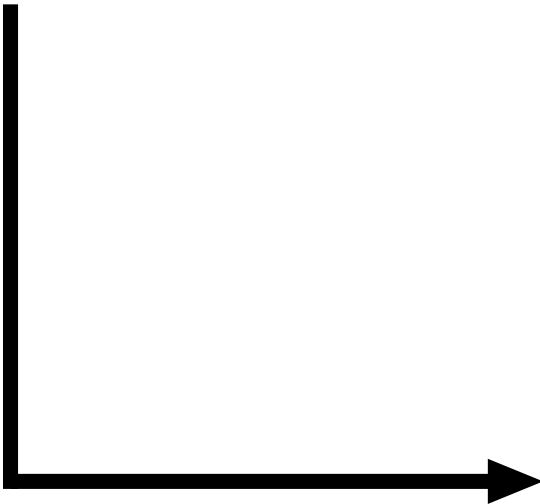

# ប៉ាញ៉ាស

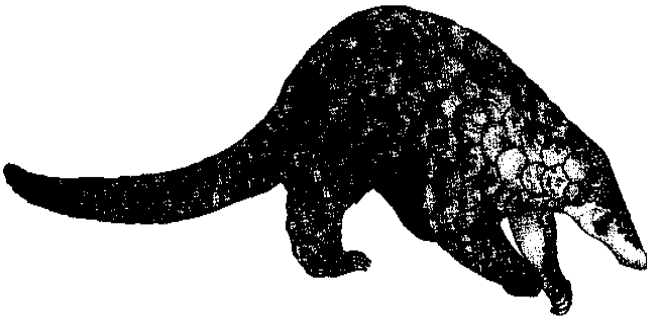

នេះជាលើកទីដំបូងហើយ ដែលក្រុមការងារយើងខ្ញុំ បានរៀបចំ  
សៀវភៅពាក្យបណ្តៅជាភាសាទំពួន  
បោះពុម្ពលើកទី២ចំនួន ១៥ ក្បាល  
ខែ ធ្នូ ឆ្នាំ២០១០  
បើចង់បានព័ត៌មានបន្ថែមទៀត  
សូមទាក់ទងមកតាមអាសយដ្ឋានខាងក្រោមនេះ  
អង្គការសហការអន្តរជាតិកម្ពុជា ( ICC)  
P.O BOX 612  
ភ្នំពេញ កម្ពុជា  
Tel: 092 469 934  
ឬ  
P.O BOX 890003  
បានលុង រតនគីរី  
Tel: 075 974 029  
E-mail: [ride.pm@icc.org.kh](mailto:ride.pm@icc.org.kh)





Prepared for first online distribution in March 2015 by



អង្គការសហការអន្តរជាតិកម្ពុជា  
International Cooperation Cambodia  
P.O. Box 612, Phnom Penh, Cambodia  
Tel: 092-469-934 / 075-974-029  
[info@icc.org.kh](mailto:info@icc.org.kh)  
<http://www.icc.org.kh>



This work is dual licensed under either of these Creative Commons licenses:

- Attribution-ShareAlike 4.0 International License.(Cc-BY-SA) To view a copy of this license, visit <http://creativecommons.org/licenses/by-sa/4.0/>.
- Attribution-NonCommercial-ShareAlike (CC BY-NC-SA) To view a copy of this license, visit <http://creativecommons.org/licenses/by-nc-sa/4.0/>.

**You are free to:**

**Share** — copy and redistribute the material in any medium or format

**Adapt** — remix, transform, and build upon the material  
for any purpose, even commercially.

The licensor cannot revoke these freedoms as long as you follow the license terms.



**Under the following terms:**

**Attribution** — You must give appropriate credit, provide a link to the license, and indicate if changes were made. You may do so in any reasonable manner, but not in any way that suggests the licensor endorses you or your use.



**ShareAlike** — If you remix, transform, or build upon the material, you must distribute your contributions under the same license as the original.

**No additional restrictions** — You may not apply legal terms or technological measures that legally restrict others from doing anything the license permits.